

All rights reserved / Schutzvermerk nach DIN ISO 16016 beachten

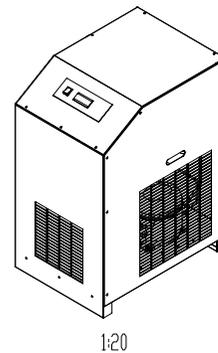
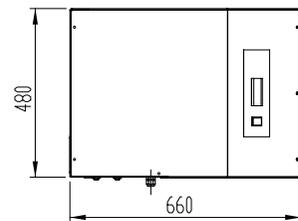
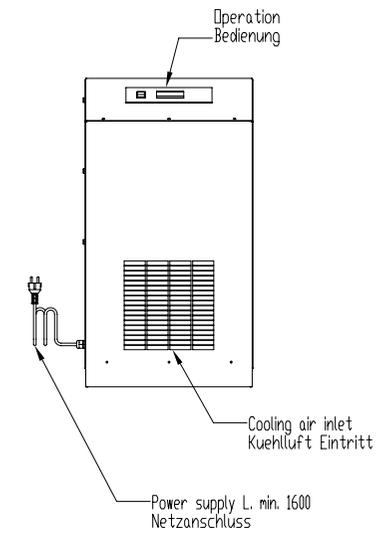
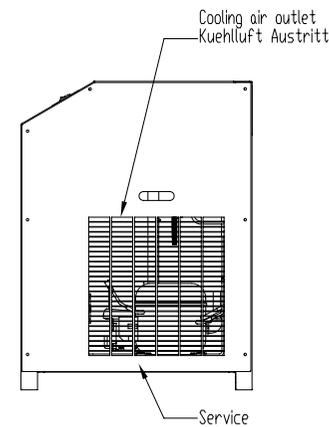
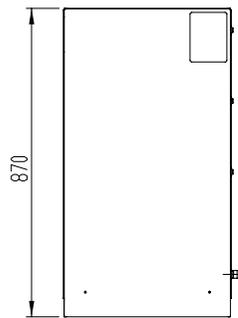
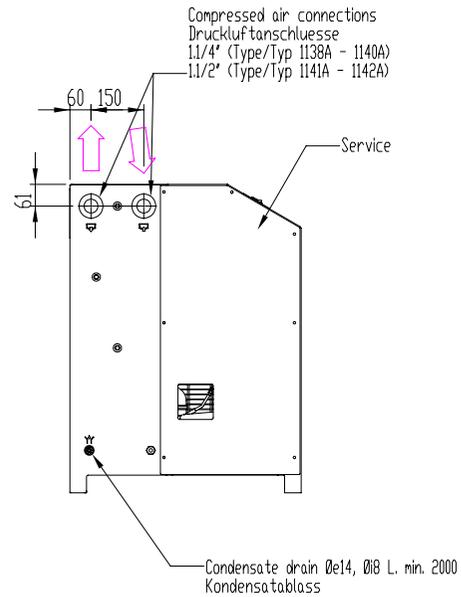
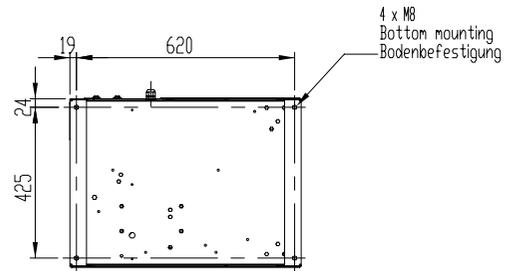

Type Typ	Weight Gewicht
1138 A	55 kg
1139 A	56 kg
1140 A	57 kg
1141 A	61 kg
1142 A	68 kg

Technische Aenderungen vorbehalten! Technical modifications are subject to change without notice, errors not excluded				Maßstab / Scale		Gewicht / Weight		Format	
Allgemeintoleranz fuer Schweisskonstruktionen/ General tolerance for welded constructions DIN 8570 / 1 B		Allgemein- toleranz / Tolerance ISO 2768-m-k		Werkstueck -kanten Part edges DIN 6784		1:15		A3	
				Werkstoff / Material					
				Benennung / Title		<b>RKT-CQ 0180 - 0450 AB</b>			
				Zeichnungsnummer / Drawing No.					
				Date		Name		Page 1	
				Draw. 24.03.10		BA		1 Pg.	
				Appr. 24.03.10		MA			
				Rev. -		-			
Rev. Aenderung / Notes				Date		Name			